



■ 特性

- 国际通用全范围交流输入
- 内置 EMI 滤波器
- 过压/过温/过负载保护
- 100%负载老化
- 冷却方式: 自冷
- LED 电源指示灯
- 高效率, 长寿命和高信赖度
- 可根据用户选型定制
- 能效等级 Level V

■ Characteristic

- International Universal AC input/ Full range
- Built-in EMI filter
- Over voltage & temperature & Load Protections
- 100% full load burn-in test
- Cooling: Self-cooling
- LED indicator for power
- High efficiency, long life and high reliability
- Can be customized according to user selection
- Energy efficiency grade Level V

电气规格 SPECIFICATION

型号 Model		AD-S0530BE	AD-S0926BE	AD-S1220BE	AD-S1516BE	AD-S1813BE	AD-S2410BE	AD-S4805BE	
输出 Output	直流电压 DC Voltage	5V	9V	12V	15V	18V	24V	48V	
	额定电流 Rated Current	3A	2.66A	2A	1.6A	1.33A	1A	0.5A	
	电流范围 Current Range	0~3A	0~2.66A	0~2A	0~1.6A	0~1.33A	0~1A	0~0.5A	
	额定功率 Rated Power	15W	24W	24W	24W	24W	24W	24W	
	波纹和噪声(最大)备注2 Ripple & Noise Max Note	75mVp-p	100mVp-p	120mVp-p	150mVp-p	150mVp-p	150mVp-p	150mVp-p	
	电压精度备注3 Voltage Tolerance Note 3	±5%	±5%	±5%	±3%	±3%	±3%	±2%	
	线性调整率备注4 Line Regulation (Note 4)	±1%	±1%	±1%	±1%	±1%	±1%	±1%	
	负载调整率备注5 Load Regulation (Note 5)	±2%	±2%	±2%	±2%	±2%	±2%	±2%	
启动, 上升, 保持时间 Setup, Rise Time	500ms 200ms 30ms 满载时 Full load								
输入 Input	交流插头 AC plug	AC 插头-CCC		AC 插头-UL	AC 插头-CE		AC 插头-BS		
	电压范围 Voltage Range	100Vac~240Vac							
	频率范围 Frequency Range	50/60Hz							
	效率最大 Efficiency (Typ.)	80%	80%	83%	83%	84%	85%	85%	
	交流电流 Ac Current (Typ.)	0.6A/110Vac 0.3A/200Vac							
	浪涌电流最大 Inrush Current (Typ.)	45A/220Vac							
	漏电流最大 Leakage Current (Typ.)	< 0.35mA/220Vac							
保护 Protection	过负载 Over Load	额定输出功率的 Rated output power: 110%~175% 保护模式: 打嗝模式, 负载异常条件移除后可自动恢复 Protection type: Hiccup mode, recovers automatically after fault condition is removed							
	过电流 Over Voltage	额定输出电流的 Rated output Voltage: 110%~175% 保护模式: 二极管钳位 Protection mode: diode clamp							
	过温度备注5 Over Temp (Note 5)	晶体内部接点温度超过 140℃, 启动过温保护。 Crystal internal contact temperature exceeds 140℃, start over temperature protection. 保护模式: 关闭输出电压, 温度下降后自动恢复 Protection mode: turn off the output voltage, the temperature drops automatically resume							
环境 Environment	工作温度 Working Temp	-0℃~50℃ (请参照“减额曲线” Refer to "Derating curve")							
	工作湿度 Working Humidity	0~90%RH, 无冷凝 non-condensing							
	储存温度、湿度 Storage Temp, Humidity	-10℃~75℃ 10~98%RH, 无冷凝 non-condensing							
	温度系数 Temp. Coefficient	±0.03%/℃ (0~50℃)							
	耐震荡 Vibration	10~500Hz, 5G 10分钟/周期, X、Y、Z轴 各60分钟 10Min/1 cycle, period for 60min, each along X,Y,Z axes							
安规和电磁兼容 备注7 Safety & EMC Note 7	安全规范 Safety Standards	GB4943, EN60950							
	耐压 Withstand Voltage	I/P-O/P: 3000VAC							
	绝缘抗阻 Isolation Resistance	I/P-O/P: 100M Ohms/500VDC/25℃/70%RH							
	电磁兼容发射 EMI Conduction Radiation	符合 Compliance to :EN55022, EN61000-3-2, 3, FCC part15, GB9254 class B, GB17625.1							
	电磁兼容抗扰度 EMS Immunity	符合 Compliance to :EN61000-4-2, 3, 4, 5, 6, 8, 11, A 级轻工业标准 light industry level, criteria A							
其它 Others	寿命 Life	2年: 100%负载, 30℃, 8小时/天 2 years: 100% load, 30, 8 hours / day							
	MTBF	≥1415.6Khrs							
	尺寸 Dimension	75*50*27mm (L*W*H)							
	包装 Packing	0.08Kg 100pcs/8Kg							
连接器 Connector	插头 Plug/配线 Wiring	详见第三页, 其它型号可依客户需求订制 For second pages, other models can be customized according to customer requirements.							
备注 Note	1. 如未特别说明, 所有规格参数均在输入为 230VAC、额定负载、25℃环境温度下进行测量。 If no special instructions are specified, all the specifications are measured at the input of 230VAC, the rated load, the ambient temperature of 25℃. 2. 波纹和噪声测量方法: 使用一条 12" 双绞线, 同时终端要并联 0.1uF 和 47uF 的电容, 在 20MHZ 带宽下进行测量。 Ripple and noise measuring method: using a 12" twisted pair, at the same time terminal to parallel 0.1uF and 47uF capacitor, in the 20MHZ bandwidth measurement. 3. 精度: 包含设定误差, 线性调整率和负载调整率。 Curacy: contains setting error, linear adjustment rate and load adjustment rate. 4. 线性调整率测量方法: 在额定负载下, 从低电压到高电压测试。 Linear adjust rate measurement: at rated load, from a low voltage to a high voltage test. 5. 负载调整率测量方法: 从 10%到 100%。 Load adjustment rate measurement method: from 10% to 100% 6. 过温保护是由控制 IC 的功能决定。 Overtemperature protection is determined by the function of the control IC.								

尺寸 Dimension

单位: mm

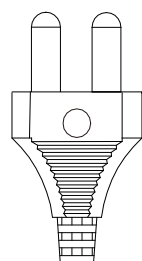
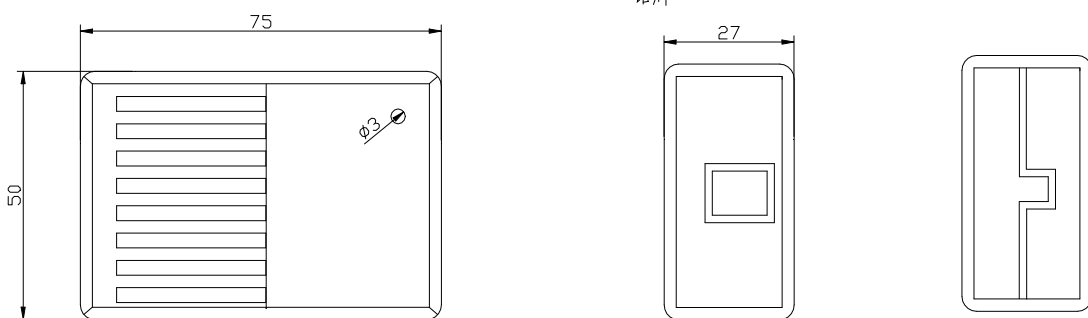
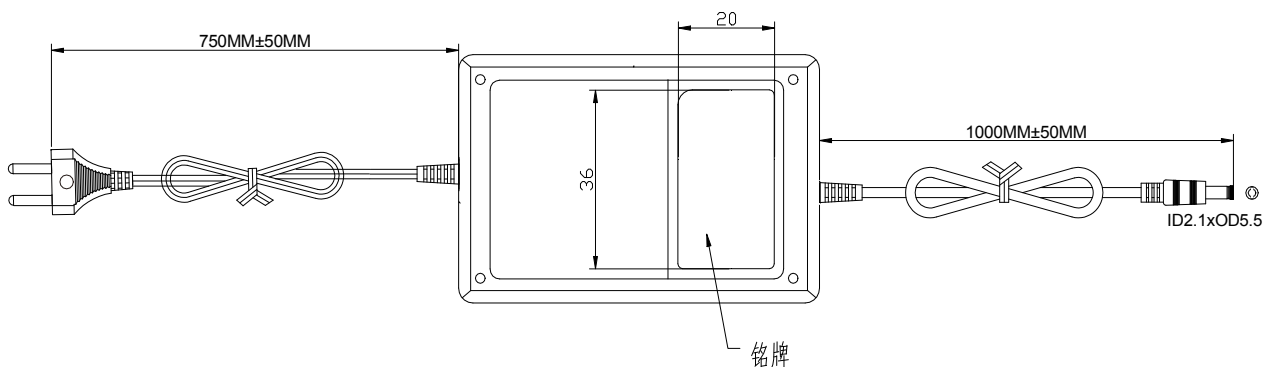

中规-CCC

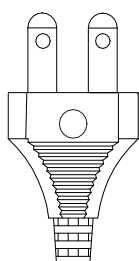

美规-UL

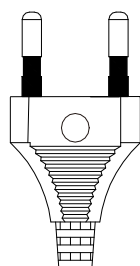

欧规-CE

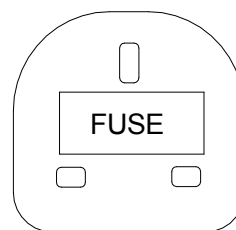

英规-BS

■ 减额曲线

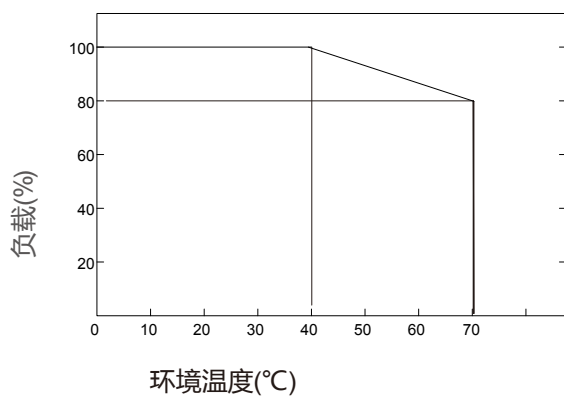

■ 静态特性曲线

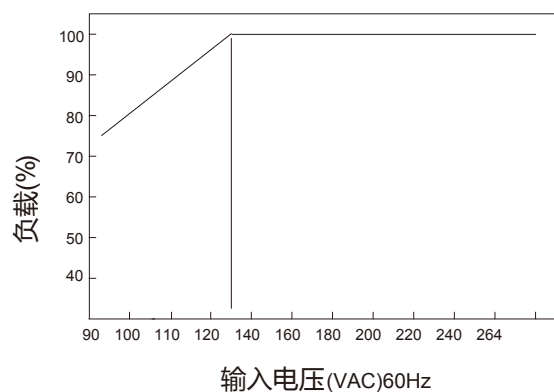

DC输出接头

◎标准型插头:P1J

单位:mm

P1J	Pin脚定义
	TuningForkStyle
	外侧 内侧

◎可选 DC插头:

TuningForkStyle		型号	A	B	C
			OD	ID	L
	(Straight)	P1I	5.5	2.1	9.5
		P1L	5.5	2.5	9.5
		P3B	4.0	1.7	11.0
		P3B	3.5	1.35	11.0
		P1M	5.5	2.5	11.0
		P1IR	5.5	2.1	9.5
	(Right-angled)	P1JR	5.5	2.1	11.0
		P1LR	5.5	2.5	9.5
		P1MR	5.5	2.5	11.0
		P3BR	4.0	1.7	11.0
		P3CR	3.5	1.35	11.0
BarrelStyle		型号	A	B	C
			OD	ID	L
	(Straight)	P2I	5.5	2.1	9.5
		P2J	5.5	2.1	11.0
		P2L	5.5	2.5	9.5
		P2M	5.5	2.5	11.0
	(Right-angled)	P2IR	5.5	2.1	9.5
		P2JR	5.5	2.1	11.0
		P2LR	5.5	2.5	9.5
		P2MR	5.5	2.5	11.0