



三一精工

集中供电箱 Centralized power supply box

SD-CH18/150W



■ 特性

■ Characteristic

- 国际通用全范围交流输入
- 内置 EMI 滤波器
- 具有过流及短路保护
- 过压/过温/过负载保护
- 100%负载老化
- 冷却方式：自冷
- LED 电源指示灯
- 高效率，长寿命和高信赖度
- 可根据用户选型定制

- International Universal AC input/ Full range
- Built-in EMI filter
- Short circuit/Over load Protections
- Over voltage& temperature & Load Protections
- 100% full load burn-in test
- Cooling: Self-cooling
- LED indicator for power
- High efficiency, long life and high reliability
- Can be customized according to user selection

电气规格 SPECIFICATOIN

型号 MODEL		AD-S05250AA	AD-S09150AA	AD-S12120AA	AD-S15100AA	AD-S2460AA	AD-S4830AA
输出 Output	直流电压 DC Voltage	5V	9V	12V	15V	24V	48V
	额定电流 Rated Current	25A	15A	12A	10A	6A	3A
	电流范围 Current Range	0~25A	0~15A	0~12A	0~10A	0~6A	0~3A
	额定功率 Rated Power	125W	135W	144W	150W	144W	144W
	波纹与噪声最大 (备注2) Ripple & Noise Max (Note2)	120mVp-p	120mVp-p	120mVp-p	120mVp-p	120mVp-p	120mVp-p
	电压调整范围 Voltage Adj. Range	±10%	±10%	±10%	±10%	±10%	±10%
	电压精度 (备注3) Voltage Tolerance (Note 3)	±7%	±7%	±6%	±5%	±5%	±5%
	线性调整率 (备注4) Line Regulation (Note 4)	±0.5%	±0.5%	±1%	±1%	±1%	±1%
	负载调整率 (备注5) Load Regulation (Note 5)	±2.0%	±1.0%	±1.0%	±1.0%	±1.0%	±1.0%
	启动、上升时间 Setup、Rise Time	500ms, 30ms/220Vac (满载时 Full load)					
保持时间 (Typ.) Hold up time (Typ.)	100ms/220Vac (满载时 Full load)						
输入 Input	电压范围 Voltage Range	100~240Vac					
	频率范围 Frequency Range	50/60Hz					
	效率 (Typ.) Efficiency (Typ.)	82%	82%	85%	85%	82%	82%
	交流电流 (Typ.) Ac Current (Typ.)	2.4A/220Vac					
	浪涌电流 (Typ.) Inrush Current (Typ.)	冷启动 Cold Start: 50A/220Vac					
漏电流 (Typ.) Leakage Current (Typ.)	3.5mA						
保护 Protection	过载保护 Over load protection	110%~135% 保护模式：打嗝模式，负载异常条件移除后可自动恢复 Protection type: Hiccup mode, recovers automatically after fault condition is removed					
	过压保护 Over Voltage protection	115%~150% 保护模式：打嗝模式，过压异常条件移除后可自动恢复 Protection type: Hiccup mode, recovers automatically after fault condition is removed					
	过温保护 Over-temperature protection	保护模式：晶体内部接点温度超过 140℃，关闭输出，当温度恢复正常可自动恢复 Protected Mode: crystal internal contact temperature exceeds 140℃, turn off the output, when the temperature returns to normal automatic recovery					
环境 Environment	工作温度 Working Temp	-10℃~60℃ (请参照“减额曲线” Refer to "derating curve")					
	工作湿度 Working Humidity	20~90%RH, 无冷凝 non-condensing					
	储存温度、湿度 Storage Temp、Humidity	-30℃~75℃ 10~98%RH, 无冷凝 non-condensing					
	温度系数 Temp Coefficient	±0.03% /℃ (0~50℃) (+5V)					
	耐振荡 Vibration	10~500Hz, 5G 10分钟/周期, X、Y、Z 轴各 60分钟 10Min/1 cycle, period for 60min,each along X,Y,Z axes					
安规和电磁兼容 (备注7) Safety & EMC (Note 7)	安全规范备注6 Safety Standards Note 6	GB4943, EN60950					
	耐压 Withstand Voltage	I/P-O/P:3KVAC I/P-FG:1.5KVAC O/P-FG:1.5KVAC					
	绝缘阻抗 Isolation Resistance	I/P-O/P I/P-FG O/P-FG:100M Ohms/500VDC/25℃/70%RH					
	电磁兼容发射 EMI Conduction Radiation	符合 Compliance to :EN55022, EN61000-3-2, 3, FCC part15, GB9254 class B, GB17625.1					
其它 Others	电磁兼容抗扰度 EMS Immunity	符合 Compliance to :EN61000-4-2, 3, 4, 5, 6, 8, 11, A 级轻工业标准 light industry level, criteria A					
	MTBF	≥100000h.					
备注 Note	尺寸 Dimension/包装 Packing	234*316*62mm(L*W*H) 1.8Kg;12pcs/21.6Kg					
	1. 如未特别说明，所有规格参数均在输入为 220VAC、额定负载、25℃环境温度下进行测量。 All parameters NOT specially mentioned are measured at 220VAC input, rated load and 25℃ of ambient temperature. 2. 波纹和噪声测量方法：使用一条 12" 双绞线，同时终端要并联 0.1uF 和 47uF 的电容，在 20MHZ 带宽下进行量测。 Ripple & noise are measured at 20MHZ of bandwidth by using a 12" twisted pair-wire terminated with a 0.1uF & 47uF parallel capacitor 3. 精度：包含设定误差，线性调整率和负载调整率。 Tolerance: includes set up tolerance, line regulation and load regulation 4. 线性调整率测量方法：在额定负载下，从低电压到高电压测试。 Line regulation is measured from low line to high line at rated load. 5. 负载调整率测量方法：从 0% 到 100% 额定负载。 Load regulation measurement: from 0% to rated load of 100% 6. 按照 GB4943.1 的要求，电源仅适用于海拔 2000 米以下地区和非热带气候条件下安全使用。 In accordance with the requirements of GB4943.1 power applies only to an altitude of 2000 meters in the following areas and non-tropical climate conditions for safe use 7. 电源被视为系统内元件的一部分，需结合终端设备进行电磁兼容相关确认。 The power supply is considered part of the system components, to be with terminal equipment related to electromagnetic compatibility Relevant confirmation.						



尺寸 Size

单位: mm

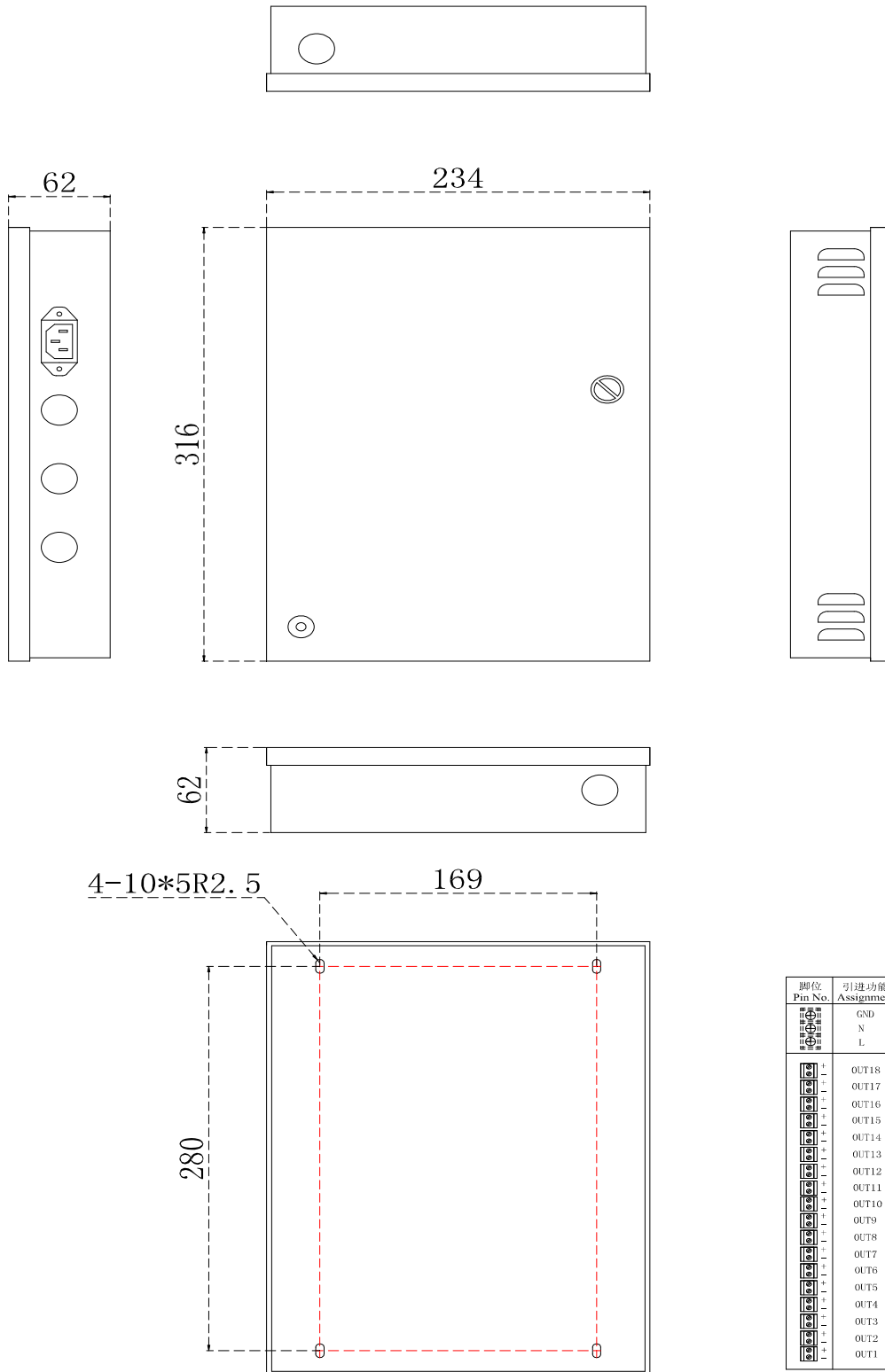

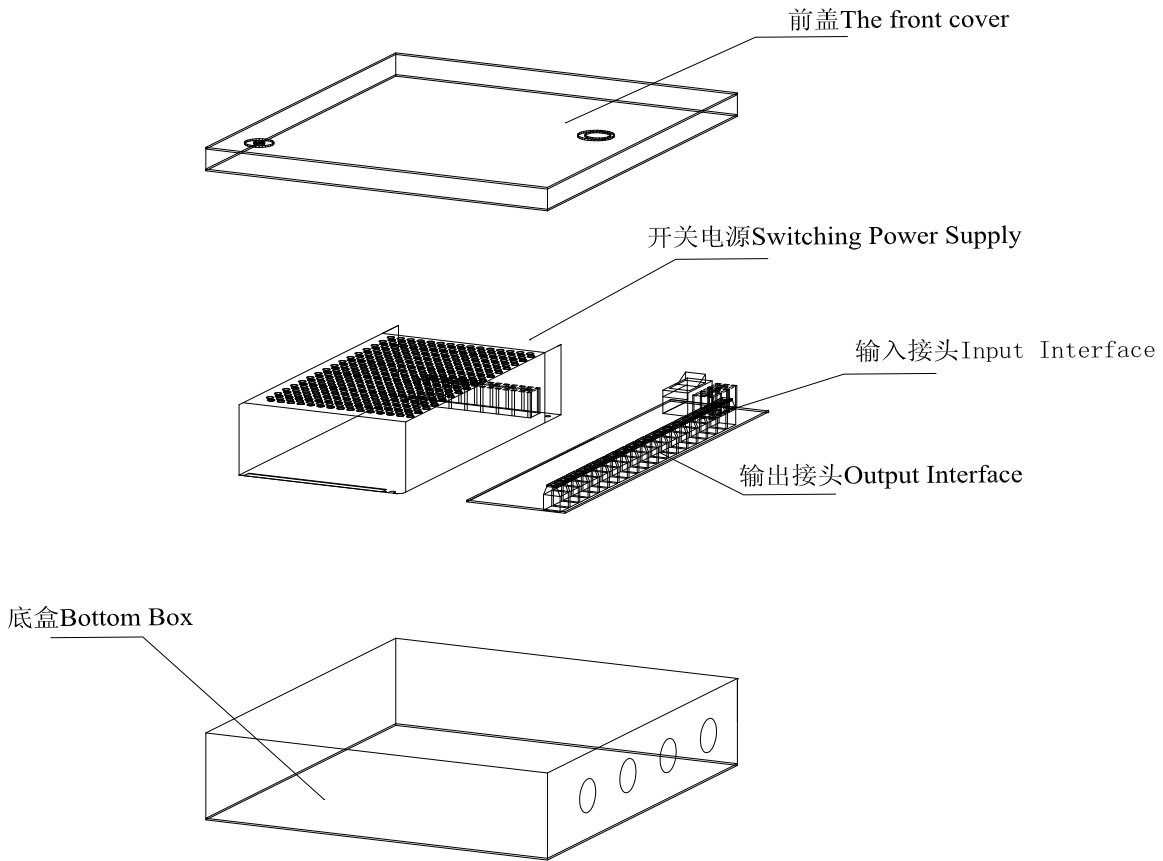

■ 方框图

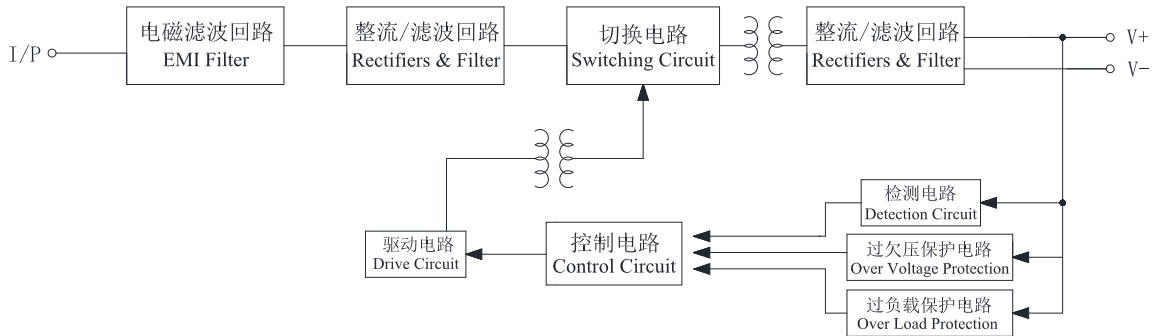

■ 减额曲线

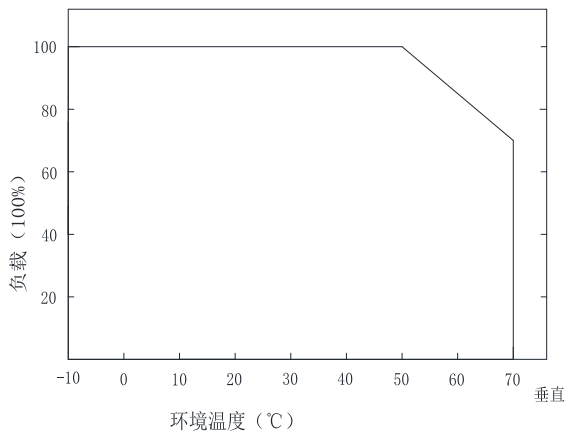

■ 静态特性曲线

