



■ 特性

- 国际通用全范围交流输入
- 内置 EMI 滤波器
- 过压/过温/过负载保护
- 100%负载老化
- 冷却方式：自冷
- LED 电源指示灯
- 高效率，长寿命和高信赖度
- 可根据用户选型定制

■ Characteristic

- International Universal AC input/ Full range
- Built-in EMI filter
- Over voltage& temperature & Load Protections
- 100% full load burn-in test
- Cooling: Self-cooling
- LED indicator for power
- High efficiency, long life and high reliability
- Can be customized according to user selection

电气规格 SPECIFICATION

型号 Model		AD-S05100B	AD-S0980B	AD-S1270B	AD-S1560B	AD-S1850B	AD-S2440B	AD-S4820B
输出 Output	直流电压 DC Voltage	5V	9V	12V	15V	18V	24V	48V
	额定电流 Rated Current	10A	8A	7A	6A	5A	4A	2A
	电流范围 Current Range	0~10A	0~8A	0~7A	0~6A	0~5A	0~4A	0~2A
	额定功率 Rated Power	50W	72W	84W	90W	90W	96W	96W
	波纹和噪声(最大)备注2Ripple & Noise Max Note	120mVp-p	120mVp-p	120mVp-p	120mVp-p	120mVp-p	120mVp-p	120mVp-p
	电压精度备注3 Voltage Tolerance Note 3	±5%	±5%	±5%	±5%	±3%	±3%	±3%
	线性调整率备注4 Line Regulation (Note 4)	±1%	±1%	±1%	±1%	±1%	±1%	±1%
	负载调整率备注5 Load Regulation (Note 5)	±2%	±2%	±2%	±2%	±2%	±2%	±2%
启动, 上升, 保持时间 Setup、Rise Time		500ms 200ms 30ms 满载时 Full load						
输入 Input	交流插头 AC plug	AC 插头-UK		AC 插头-CN		AC 插头-EN		AC 插头-US
	电压范围 Voltage Range	100Vac~240Vac						
	频率范围 Frequency Range	50/60Hz						
	效率最大 Efficiency (Typ.)	80%	80%	84%	83%	84%	82%	82%
	交流电流 Ac Current (Typ.)	0.6A/200Vac						
	浪涌电流最大 Inrush Current (Typ.)	50A/220Vac						
	漏电流最大 Leakage Current (Typ.)	< 0.6mA/220Vac						
保护 Protection	过负载 Over Load	额定输出功率的 Rated output power: 110%~240% 保护模式: 打嗝模式, 负载异常条件移除后可自动恢复 Protection type: Hiccup mode, recovers automatically after fault condition is removed						
	过电流 Over Voltage	额定输出电流的 Rated output Voltage: 115%~135% 保护模式: 二极管钳位 Protection mode: diode clamp						
	过温度备注5 Over Temp (Note 5)	晶体内部接点温度超过 140℃, 启动过温保护。 Crystal internal contact temperature exceeds 140 °C, start over temperature protection. 保护模式: 关闭输出电压, 温度下降后自动恢复 Protection mode: turn off the output voltage, the temperature drops automatically resume						
环境 Environment	工作温度 Working Temp	-0℃~50℃ (请参照“减额曲线” Refer to "Derating curve")						
	工作湿度 Working Humidity	0~90%RH, 无冷凝 non-condensing						
	储存温度、湿度 Storage Temp、Humidity	-10℃~75℃ 10~98%RH, 无冷凝 non-condensing						
	温度系数 Temp. Coefficient	±0.03%/℃ (0~50℃)						
	耐震荡 Vibration	10~500Hz, 5G 10分钟/周期, X、Y、Z轴各60分钟 10Min/1 cycle, period for 60min, each along X,Y,Z axes						
安规和电磁兼容 备注7 Safety & EMC Note 7	安全规范 Safety Standards	GB4943, EN60950						
	耐压 Withstand Voltage	I/P-0/P: 2KVac						
	绝缘抗阻 Isolation Resistance	I/P-0/P: 100M Ohms/500VDC/25℃/70%RH						
	电磁兼容发射 EMI Conduction Radiation	符合 Compliance to :EN55022, EN61000-3-2, 3, FCC part15, GB9254 class B, GB17625.1						
	电磁兼容抗扰度 EMS Immunity	符合 Compliance to :EN61000-4-2, 3, 4, 5, 6, 8, 11, A 级轻工业标准 light industry level, criteria A						
其它 Others	寿命 Life	2年: 100%负载, 30℃, 8小时/天 2 years: 100% load, 30, 8 hours / day						
	MTBF	≥1415.6Khrs						
	尺寸 Dimension	124*50*32mm (L*W*H)						
	包装 Packing	0.22Kg 100pcs/22Kg						
连接器 Connector	插头 Plug/配线 Wiring	详见第二页, 其它型号可依客户需求订制 For second pages, other models can be customized according to customer requirements.						
备注 Note	1. 如未特别说明, 所有规格参数均在输入为 230VAC、额定负载、25℃环境温度下进行测量。 If no special instructions are specified, all the specifications are measured at the input of 230VAC, the rated load, the ambient temperature of 25℃. 2. 波纹和噪声测量方法: 使用一条 12" 双绞线, 同时终端要并联 0.1uF 和 47uF 的电容, 在 20MHz 带宽下进行量测。 Ripple and noise measuring method: using a 12" twisted pair, at the same time terminal to parallel 0.1uF and 47uF capacitor, in the 20MHz bandwidth measurement. 3. 精度: 包含设定误差, 线性调整率和负载调整率。 Curacy: contains setting error, linear adjustment rate and load adjustment rate. 4. 线性调整率测量方法: 在额定负载下, 从低电压到高电压测试。 Linear adjust rate measurement: at rated load, from a low voltage to a high voltage test. 5. 负载调整率测量方法: 从 10%到 100%。 Load adjustment rate measurement method: from 20% to 100% 6. 过温保护是由控制 IC 的功能决定。 Overtemperature protection is determined by the function of the control IC.							

尺寸 Dimension

单位: mm

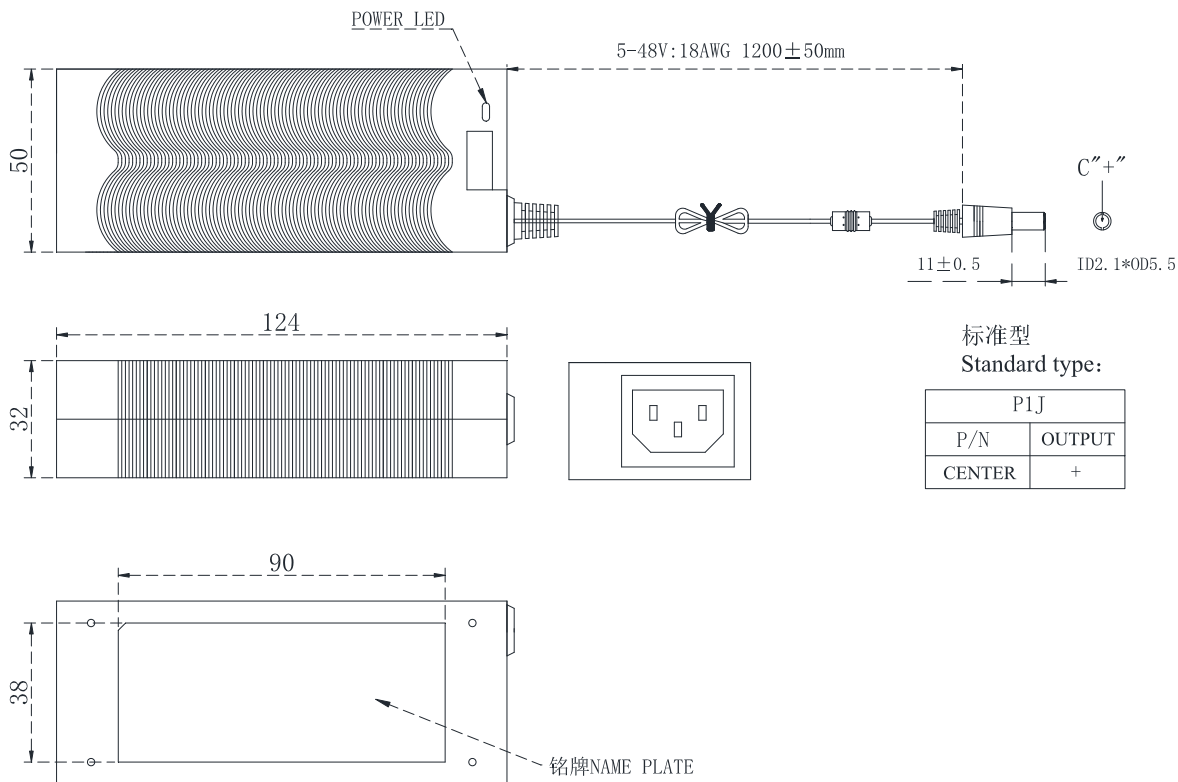

方框图

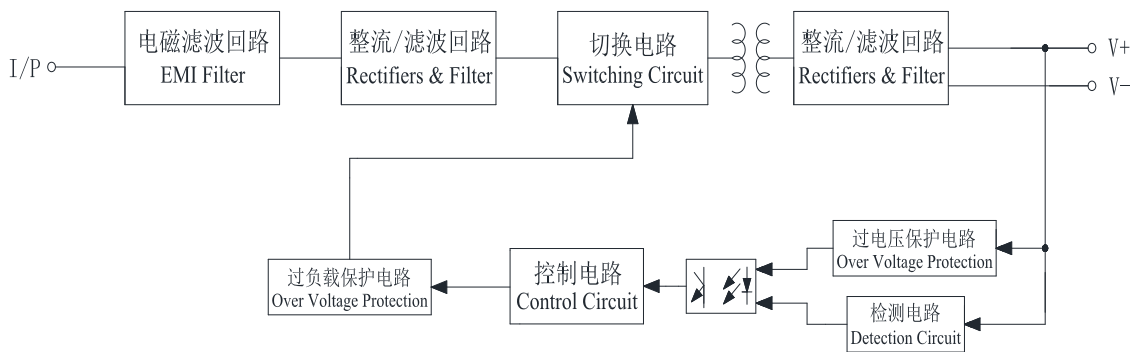

减额曲线

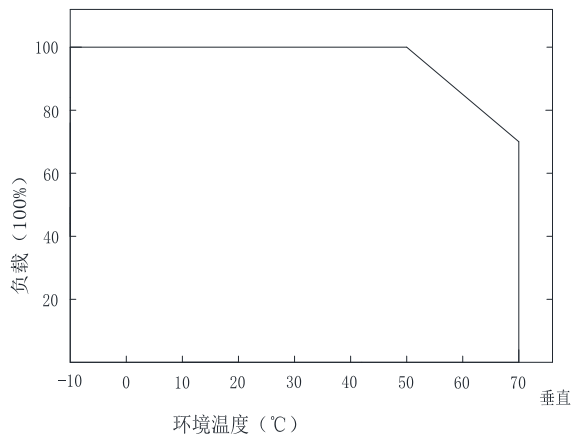

静态特性曲线

